

Product Features



- Aluminum housing duly powder coated.
- Long life and better thermal management.
- High efficacy LED.
- Uniform and optimum light output and energy savings.
- Higher PF, Lower THD and Surge Protection.



Electrical Specification	Rated Voltage (V)	220-240Vac
	Operating Voltage Range (V)	90-305Vac
	Operating Frequency (Hz)	50 +/-3%
	Power Factor	> 0.95
	A-THD	< 10
	System Power Consumption (W)± 10%	3W
	Inbuilt Surge Protection (kV)	2.5KV
	Electrical Insulation Class	Suitable for Class II
Optical Specification	Light Source	LED
	Typ. Fixture Efficacy (LM/W)	90
	Color Temperature (K)	CDL / NDL / WDL
	CRI	80
	Diffuser / Optical material	Optical grade
	Beam Angle options	24°
Other Specification	Operating Ambient Temperature (°C)	0°C to + 45°C
	Housing	Powder coated Aluminum Hosing
	Mounting Arrangement	Recessed mount
	IP rating	IP20

Model No.

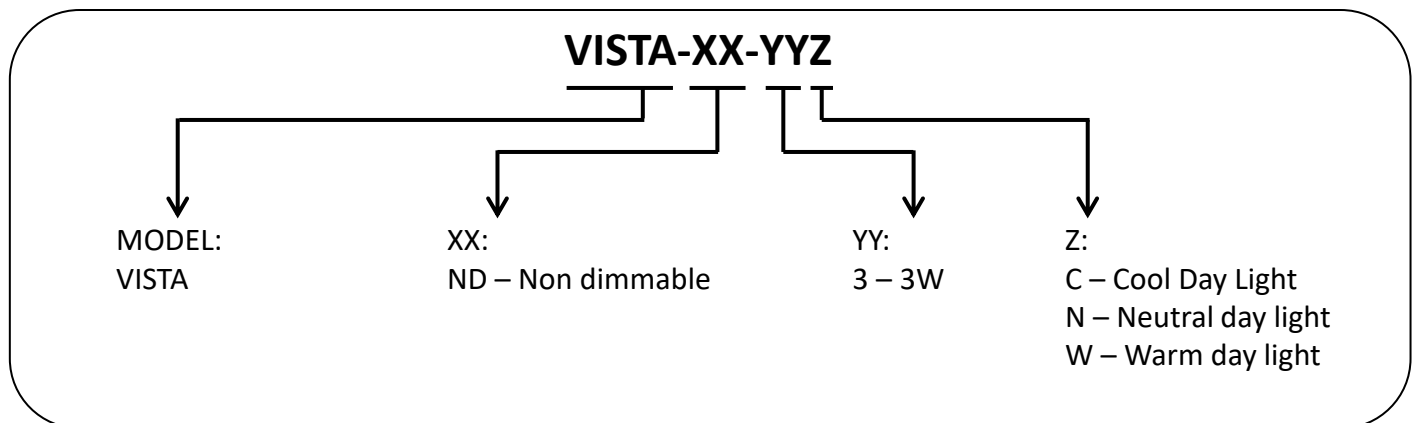

All features, functionality and other product specifications are subject to change without notice or obligation.